

Nikon Motor Drive

MD-4

INSTRUCTION MANUAL

NOMENCLATURE

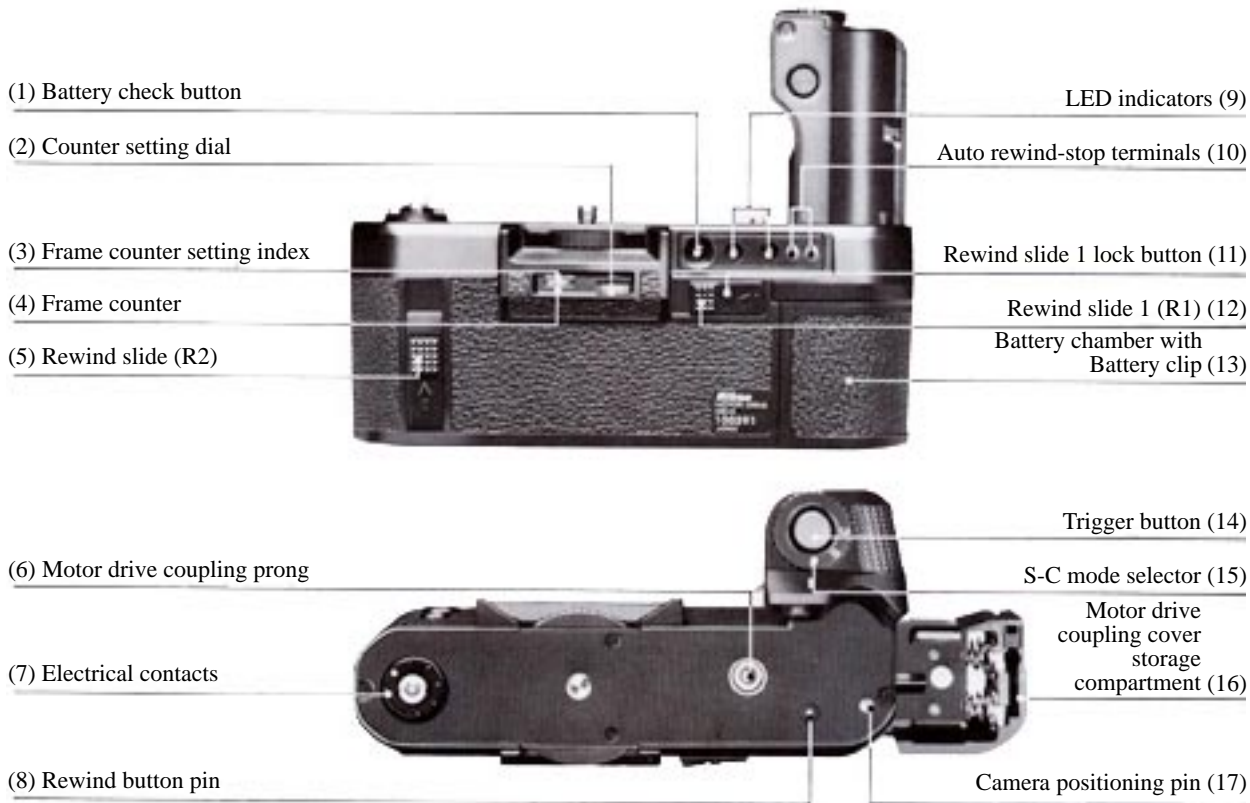

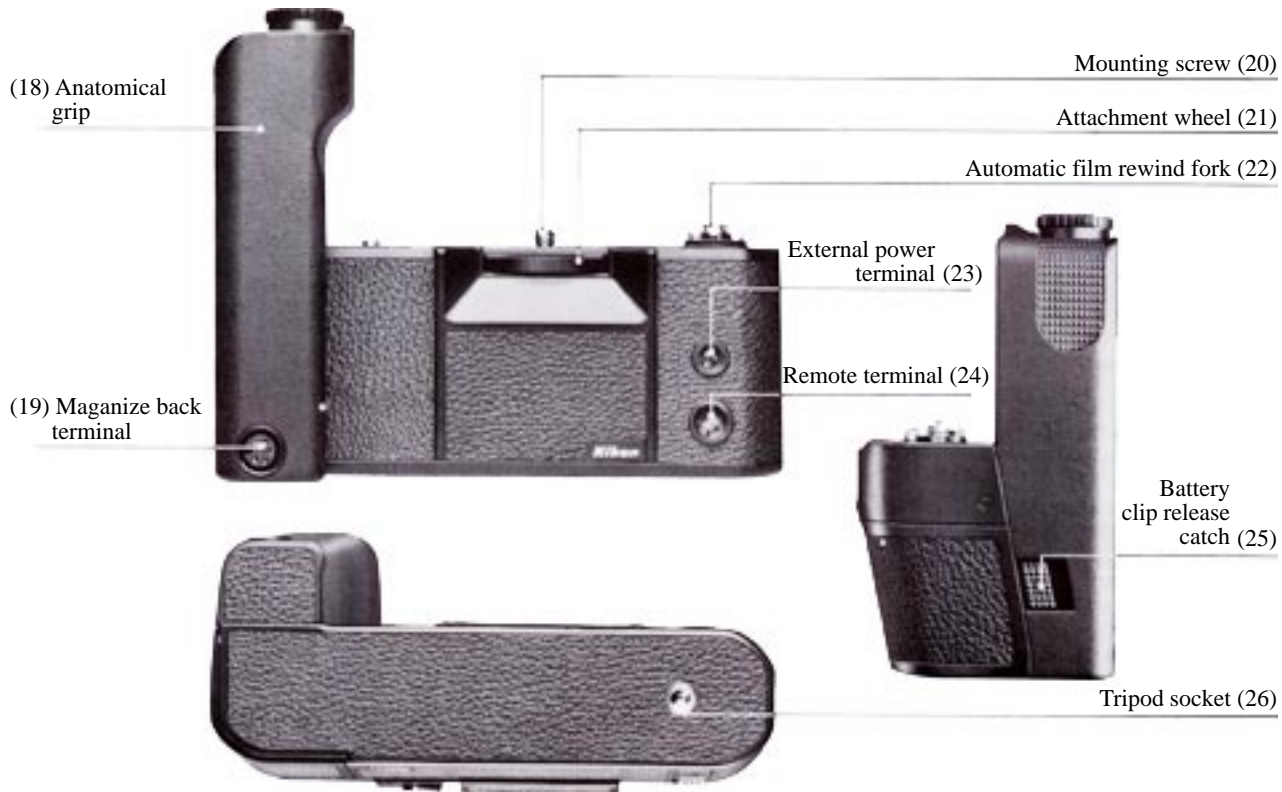

CONTENTS

NOMENCLATURE	2-3
FOREWORD	4
BASIC OPERATION	5-9
CONTROLS IN DETAIL	10-16
Anatomical Grip	10
S-C Mode Selector	10-11
(including Multiple exposures)	
Trigger Button	12
Frame Counter	12-13
Rewind Slides 1 (R1) and 2 (R2)	14
Battery Chamber	15
Battery Check Button and LED Indicators	16
Electrical Terminals	16
(Magazine back terminal/External power terminal/Remote terminal)	
ACCESSORIES	17 - 21
Power Accessories	17
(MN-2 NiCd Battery Unit and MH-2 Quick Charger/MA-4 AC/DC Converter and MC-11 External Power Cord)	
Convenient Accessories	18
(MF-6 Camera Back/Pistol Grip Model 2 and MC-3 Connecting Cord/AH-2 Tripod Adapter)	
Remote Control Accessories	19-20
(MC- 12 Remote Cord with Button Release /MW-1 Radio Control Set and MC-S Connecting Cord/ML-1 Modulite Remote Control Set and MC-8 Connecting Cord/ MR-2 Terminal Release)	
Simultaneous and Time Lag Shooting Accessories	21
(MC-4 Remote Cord/MT-1 Intervalometer and MC-S Connecting Cord/Time-lapse exposures)	
SPECIFICATIONS	22
OPTIMUM BATTERY PERFORMANCE	23

FOREWORD

*Congratulations. You now own the MD4 Motor Drive, an accessory designed to advance the film automatically through the Ni*on F3 camera. The MD-4 offers either "Single" or "Continuous" operation. At "S," the film advances to the next frame as soon as the picture is taken. At "C," it will be advanced at 4 frames per second with penlight batteries or at 6 fps when using the optional MN-2 NiCd Battery Unit. In addition, the MD-4 offers automatic film rewind. Even though the MD4 is extremely easy to use, you should still familiarize yourself with its basic operation as presented in the first section. For more detailed explanations and special picturetaking situations, refer to the sections CONTROLS IN DETAIL and ACCESSORIES. A few minutes wisely invested now will pay off in years of rewarding photographic experiences.*

BASIC OPERATION



1. Unscrew the camera's motor drive coupling cover.

First make sure the camera's power switch is turned off. Then turn the camera upside down and use a coin to unscrew the cover. Remove the motor drive's battery clip (13). Slide the release catch (25) to the right and the battery clip will pop out.



2. Remove the motor drive's battery clip (13).

Slide the release catch (25) to the right and the battery clip will pop out.



3. Store the cover in the compartment (16) provided.

To prevent the cover from being misplaced, slip it into the storage compartment on the end of the battery clip. To remove the motor drive coupling cover, push the small catch to the outside as you turn the battery clip upside down. The cover will then fall out.

BASIC OPERATION — continued



4. Load the batteries.

Install 8 AA-type penlight batteries into the clip following the "+" and "-" indications.



5. Install the battery clip.

Put the clip back in the battery chamber (13). Push it until it snaps into place.



6. Check the battery power.

Push the battery check button (1). If both LED's (9) light up, the batteries have been loaded properly and their power is sufficient. If one LED glows, the batteries should be replaced with a fresh set. If none go on, this indicates that the batteries have not been loaded correctly or are completely dead.

BASIC OPERATION — continued



7. Attach the motor drive to the camera body.

Make sure the S-C mode selector (15) of the motor drive is set to L (Lock) before attaching the camera. Otherwise the motor might start operating. Place the camera body on top of the motor drive so that the motor drive's mounting screw (20) lines up with the camera's tripod socket and the camera positioning pin (17) is aligned with the motor drive coupling hole. Then turn the attachment wheel (21) counter-clockwise until the two units are screwed tightly together.



8. Load the camera with film.

Load film into the camera in the normal way.

Note: Do not detach the motor drive from the camera while it's still loaded with film. Unless you are in a darkroom, the film might become exposed to light entering through the bottom of the camera.

BASIC OPERATION — continued



9. Set the frame counter (4) to the orange dot.

Turn the counter setting dial (2) until the frame counter reaches the orange dot.



10. Set the S-C mode selector (15).

Lift up and set the S-C mode selector for either S (SINGLE) or C (CONTINUOUS) operation.



11. Take the picture(s).

Depress the trigger button (14) halfway to switch on the meter. If you're satisfied with the reading, push the button all the way down to take the shot (s).

BASIC OPERATION — continued



12. Rewind the film automatically.

When the film reaches the end of the roll, it will automatically stop and one LED will light up. Depress the lock button (11) on rewind slide I (R1) (12) and push the slide to the left. Then, while holding it, push rewind slide 2 (R2) (5) up. Immediately the film starts rewinding. When the sound becomes more high-pitched, push rewind slide 2 back down to stop film rewinding.



13. Remove the film cartridge.

Unload the camera in the normal manner.



14. Turn the S-C mode selector to the L-setting.

To prevent the shutter from being accidentally tripped between shooting sessions, turn the S-C mode selector to the L (LOCK) position.

CONTROLS IN DETAIL



Anatomical Grip (18)

The MD-4 features a new anatomical grip to permit the photographer to shoot either horizontal or vertical pictures comfortably. For horizontal shooting, hold the grip so that your thumb is behind the camera and your forefinger is on the trigger button. In this way, you can change quickly from horizontal to vertical shooting. However, another way to hold the motor drive vertically is to balance the grip in your palm with your thumb over the trigger button. This position is recommended for onehanded shooting over an extended period of time, such as when using a bracket-mount flash unit off-camera.

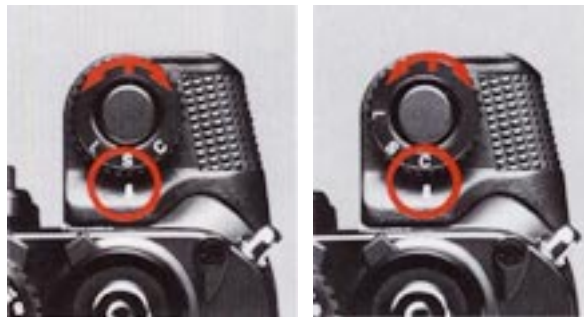

S-C Mode Selector (15)

Concentric with the trigger button for easy access, this dial sets the motor drive for either single frame (S) or continuous (C) operation. There is also a lock (L) position.

At "S" (Single Frame)

At all shutter speeds, except "B" and "T," the motor drive trips the shutter and winds the film in a single sequential step. At the same time, one LED lights up to indicate film advance. At the "B" setting, when the trigger button is pushed, the shutter fires and remains open until you take your finger off the button. Then the film advances automatically to the next frame. At "T," the shutter remains open until the shutter speed dial is rotated off the "T" setting.

Note: With the camera's power switch turned on, you can take motordriven single frame shots by using the camera's shutter release button. When you depress the button, the shot is taken, and when you release pressure from the button, the R11 B wound to the next frame. This occurs with the S-C mode selector set to either "S" or "C."



At "C" (Continuous)

As long as you hold the trigger button down, shots will be taken rapidly in succession. Any shutter speed setting, except "B" and "T," can be used. At shutter speeds slower than 1/125 sec., the firing rate automatically slows down to match the shutter speed in use.

Motor-driven multiple exposures are possible by holding the multiple exposure lever in position while firing off a short burst (see the picture above). After you're finished, make a blank shot by covering the lens with a lens cap. This will advance the film to the next unexposed frame without adding another shot to the multiple exposure just completed.

Caution: Do not hold down the backup mechanical release lever while shooting on Continuous, as the shutter will not open properly.

At "L" (Loc)

The trigger button is locked and the motor drive will not operate. However, by turning on the camera's power switch, you can use the shutter release button to trip the shutter and advance the film manually just as if the MD-4 were not attached.



Trigger Button (14)

The MD-4's trigger button, because it is an electromagnetic release, operates in exactly the same manner as the camera's shutter release button. It not only trips the shutter but serves as a meter switch as well. When depressed halfway, it turns on the meter and activates the LCD exposure information in the viewfinder. If the button is not touched again, the meter will turn itself off automatically after 16 sec. to conserve battery power.

With the MD-4 attached, it makes no difference whether the camera's power switch is turned on or not. In fact, you might find it easier to leave the switch in the OFF position and control the camera's meter entirely with the trigger button.



Frame Counter (4)

A subtractive-type frame counter is built into the MD-4. For normal shooting, set the counter to the orange dot and forget it. At this setting, the counter is disengaged and the motor drive stops automatically when the film tension increases at the end of the roll.

However, in below-freezing temperatures, film becomes brittle and easy to break. Therefore, to prevent the film from being accidentally torn, set the frame counter to the number of frames on the roll. When the counter reaches "0," the motor drive automatically shuts off before the film is damaged. One LED also lights up as a visual indication. To set the counter, turn the counter setting dial to the right until the desired number is aligned with the white index (3). 36, 24, 20, and 12 are in red corresponding to the number of

CONTROLS IN DETAIL — continued



frames in commercially-available cartridges. You can also shoot short bursts by setting the counter to the number you want (Fig. 1). When the counter reaches "0," the motor drive stops and one LED lights up (Fig. 2). To reset the frame counter for another burst, first turn the counter setting dial to the orange dot and the LED will go out (Fig. 3). Then you can rotate the counter to the desired number. Before resetting the counter, make sure to check the camera's frame counter to determine whether there are enough exposures left on the roll for the next burst.

Note: If you rewind the film before the frame counter reaches "0," the counter will not reset properly to the orange dot. Therefore, before starting to shoot your next roll of film, make sure to reset the counter to the desired setting. The film becomes brittle in low temperatures. In cold climate, be careful not to overestimate the number of frames remaining on a roll of film since this may result in the motor pulling the film off the supply spool or damaging its perforated edges. It may be a good practice to set the frame counter to one less than the number of frames remaining on a roll of film. For example, if you load a fresh S6-exp. roll, set the frame counter to 35.



Rewind Slides 1 (R1) and 2(R2) (5)

When one LED lights up to signal that the film is at an end, you must rewind the film. To simplify this operation, the MD-4 features completely automatic film rewinding. Depress the lock button on R1 and push the slide to the left. Then while holding R1 in position, push R2 up. Immediately the film will start rewinding. When the sound becomes more high-pitched, this indicates the leader has been completely rewound back into the cartridge. To stop the rewinding action, push R2 back down and immediately R1 will spring back into its original position.

If you were using the frame counter, it moves from "0" to the orange dot position as soon as R2 is pushed up.

Rewinding time for a 36-exposure roll of film with alkalinemanganese batteries is approximately 8 sec.; with the optional MN-2 NiCd Battery Unit, it is reduced to 4.5 sec.

Note: If the film is automabccally rewound in cold weather, static electncity charges may cause accidental expasures resembling lightningLalts to appear an the film. To prevent this from happening, push R1 to the leff and rewind the film slowly by hand with the camera's film rewind crank.

CONTROLS IN DETAIL — continued



Battery Chamber (13)

Instead of using a separate battery pack, the MD-4 houses its batteries in a built-in battery chamber. The standard MS-3 Battery Clip accepts 8 AA-type penlight batteries to power the motor drive up to 4 frames per second. Once the motor drive is attached, the camera gets all its power from the batteries in the motor drive. In this way, the camera is able to run on high capacity batteries. As a separate accessory, the MD-4 accepts the MN-2 NiCd Battery Unit for extremely high-speed shooting up to 6* fps. Since NiCd batteries are better able to maintain their peak performance in cold temperatures, the camera/motor drive combination will still operate down to -20°C . The following table lists the firing rates according to power source (Table 1), while the bar graph gives you the expected life of various battery types under ordinary temperatures (Table 2).



* Possible when shutter speed is 1/125 sec. or above and the mirror is locked in the "up" position.

Table 1 (frame/sec.)

Shutter speed range (sec.)	Power source			
	AA penlight batteries (Zinc-carbon)	AA penlight batteries (Alkaline-manganese)	MN-2 battery (NiCd)	MA-4(AC/DC converter)
1/125 - 1/2000	3.8	3.8	5.5	5
1/125 - 1/2000 mirror up	4	4	6	5.5

Table 2 (Number of 36-exposure rolls)

Zinc-Carbon	60	100
Alkaline-manganese)	60	140
NiCd Battery Unit MN-2	60	70

 The range of guaranteed firing rates
 The range within operative battery power but without guarantee of the specified firing rates

CONTROLS IN DETAIL — continued



Battery Check Button(1) and LED Indicators(9)

To check battery power, depress the battery check button. If both LED's light up, the power is sufficient to provide the fastest firing rates. If only one LED comes on, you can still use the MD-4, but at slower rates. If neither LED lights up, the batteries should be changed for a fresh set. The LED's also indicate other camera functions. One LED will light up: 1) each time the film is wound after a shot is taken; 2) when the film reaches the end of the roll and needs rewinding; 3) when the frame counter reaches "0"; or 4) when auto-rewinding is stopped with the optional MF-6 Camera Back.

Note: One LED will also light up if the batteries become so weak that the motor drive can no longer advance the film and just stops during the course of shooting.



Electrical Terminals

The MD-4 is provided with three separate electrical terminals.

1) Magazine back terminal (19)

Located at the bottom of the motor drive's grip, the magazine back terminal allows a magazine back to be connected to the MD-4's electrical system.

2) External power terminal (23)

The smaller of the two terminals on the front of the motor drive's base, the external power terminal allows the MA-4 AC/DC Converter to be connected to the MD-4 for extended studio shooting.

3) Remote terminal (24)

The larger of the two, the remote terminal allows a variety of remote control devices to be attached.

ACCESSORIES

Power Accessories

MN-2 NiCd Battery Unit and MH-2 Quick Charger

Optional battery unit and companion charger for the fastest firing rate. Also recommended when using the MD-4 under extremely cold weather conditions. Three to four hour recharging is possible.



MA-4 AC/DC Converter and MC-11 External Power Cord

Especially recommended when using the MD-4 for extended studio sessions. Supplies a constant 15V DC current to the motor drive. The new MC-11 Cord plugs into the external power terminal of the MD-4.

Note that the motor drive MD-4 cannot be fired by using the release button on the MA-4 AC/DC Converter.



ACCESSORIES — continued

Convenient Accessories

MF-6 Camera Back

Attached to the F3 in place of the standard camera back, the MF-6 provides automatic film rewind-stop with the film leader left outside the cartridge for ease in darkroom handling.



Pistol Grip Model 2 and MC-3 Connecting Cord

Nikon's special pistol grip can be screwed into either the camera's tripod socket or the tripod mounting collar of a supertelephoto lens to provide more stable handheld shooting. The MC-3 Cord plugs into the MD-4's remote terminal.



AH-2 Tripod Adapter (Not pictured)

A plate screwing into the bottom of the MD-4 repositions the tripod socket in the middle.

ACCESSORIES — continued

Remote Control Accessories

MC-12 Remote Control with Button Release

For remote control up to 3 meters away, the MC-12 has a handgrip and trigger release button for convenient operation. Depressing the button half-way turns on the camera's exposure meter; depressing it further releases the shutter. After finger pressure is removed, the meter stays on for 16 sec., automatically turning itself off to conserve battery power.

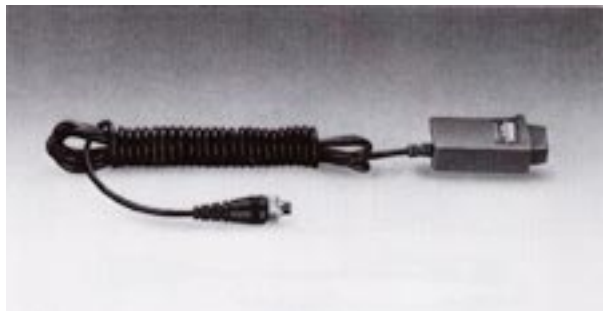

MW-1 Radio Control Set and MC-5 Connecting Cord

Provides interference-free remote control up to 0.7km. Three separate channels allow three motor-driven cameras to be operated automatically. Easy to handle. MC-S Cord plugs into the MD-4's remote terminal.



ACCESSORIES — continued

ML-1 Modulite Remote Control Set and MC-B Connecting Cord

Utilizes modulated light to control up to two motor-driven cameras automatically. Compact and easy to handle. Can be used up to 60 meters away. MC-8 Cord plugs into motor drive's remote terminal.



MR-2 Terminal Release

Allows the MD-4 to be triggered with the AR-2 Cable Release. Does not provide viewfinder display of the shutter speed when depressed halfway.



ACCESSORIES — continued

Simultaneous and Time Lag Shooting Accessories MC-4 Remote Cord

With plus and minus banana plugs, the MC-4 Cord can be used to fire up to three motor-driven F3s simultaneously. Follow the diagram for proper connection.

Note: For proper operation, the common electrical leads (indicated by bold lines in the diagram) should be kept as short as possible.

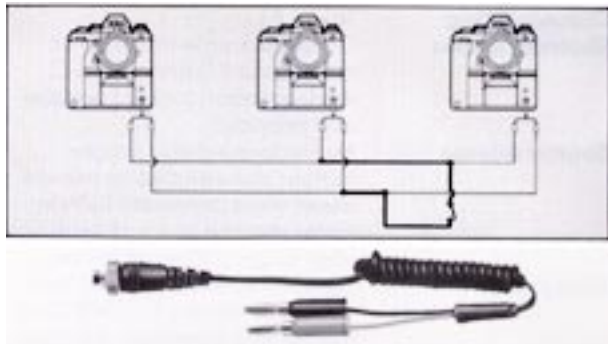

MT-1 Intervalometer and MC-5 Connecting Cord

Provides time lag shooting with the F3.

Time-lapse exposures

You can trigger the motor drive for time-lapse exposures by connecting an intervalometer or similar device to the trigger circuit in place of the ON/OFF switch. In this case, there will be a slight time delay between the moment the trigger circuit is closed and the shutter is released.

Delay time

Mirror locked-up—30 milliseconds

Mirror operating—40 milliseconds



SPECIFICATIONS

Camera fitting	Nikon F3	Number of 36-exp. rolls per fresh battery set	Guaranteed firing rate: approx. 60 with all types of batteries; slower firing rates, but still usable: approx. 70 with NiCd Battery Unit MN-2, approx. 100 with zinc-carbon batteries; approx . 140 with alkaline - manganese batteries
Shooting modes	Choice of single-frame (S) or continuous (C) firing via S-C mode selector; lock (L) position also provided	Automatic film rewind	4.5 sees. with NiCd Battery Unit MN-2 and 8 sees. with AA-type penlight batteries for 36exposure film; automatic film rewind stop with optional MF-6 Camera Back
Shutter release	By electromagnetic trigger button; also switches on camera meter when depressed halfway; meter remains on for 16 sees. after finger is lifted off button	Shutter speeds	8 to 1/2000 sec. including "X" (1/80 sec.)
Firing rate	Up to 6 frames per second (fps) with NiCd Battery Unit MN-2, up to 4 fps with 8 penlight AA-type batteries; firing rates decrease at shutter speeds slower than 1/125 sec.	Dimensions	146.5mm(W)x 115.0mm(H)x 71.0mm(D)
Automatic winding stop	Motor shuts off at film's end with LED indication; frame counter also provided to automatically stop film winding after preset number of exposures—useful in very low temperatures	Weight	480g

OPTIMUM BATTERY PERFORMANCE

1. New batteries: Between manufacturing and first use, all batteries exhibit some drain. Therefore, care should be taken to purchase the newest (and freshest) ones possible. To help you do this, some manufacturers stamp the date of manufacture on the bottom of each battery. Ask your camera dealer for assistance in interpreting the codes.
2. Temperature: Battery life ratings are based on operation at around 20°C (68°F). At other temperatures, battery life is shortened. At 0°C, for instance, battery life is shortened by as much as 2/3. Spare batteries should therefore be kept available if operation in low temperatures is anticipated.
3. Continuous use: Batteries are drained much more quickly by continuous use than by intermittent use.
4. Storage: When not in use, the batteries should be removed to prevent damage from leakage. To minimize drain during the period of disuse, store the batteries in a cool, dry place.
5. Battery brands: Do not use mixed brands of batteries, nor batteries with different model numbers. Also, avoid mixing new and old batteries since proper performance will not be obtained and battery leakage into your MD-4 may occur.
6. Disposal: Do not dispose of batteries by burning. Also, for safety's sake, do not disassemble batteries when disposing.
7. Polarity: When installing batteries, observe the voltage polarities carefully. Reversal of the positive (+) and negative (-) terminals will result in leakage. If leakage should occur, clean carefully or take your MD-4 to your dealer.